

RF Single Color Wall Mounted Controller

09.283K4.04471



Important: Read All Instructions Prior to Installation

Function introduction

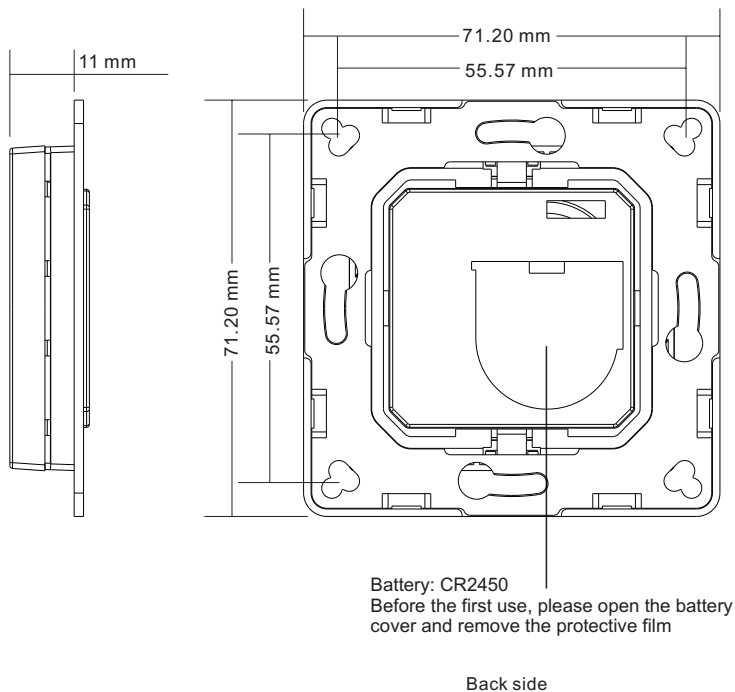
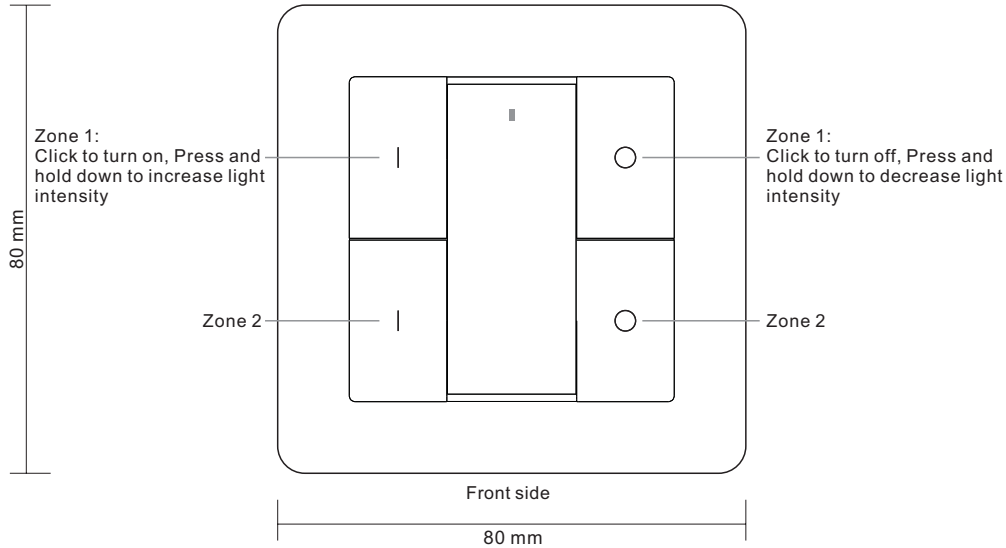

Product Data

Output	RF signal
Operation Frequency	869.5/434MHz
Power Supply	3V(1xCR2450 battery)
Operating temperature	0-40°C
Relative humidity	8% to 80%
Dimensions	80x80x13.6mm

- Control 2 zones of RF receiver
- Single color controller
- Compatible with all universal series RF receivers
- 1 receiver can be paired by max 8 different remote controls.
- Waterproof grade: IP20

Safety & Warnings

- This device contains a button lithium battery that shall be stored and disposed properly.
- DO NOT expose the device to moisture.

Pair with RF receiver

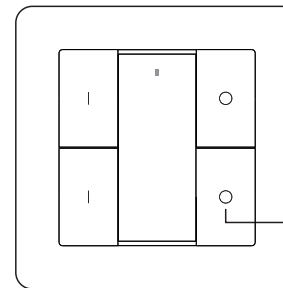

Step 1: Do wiring the RF receiver according to wiring diagram (please refer to the instruction of RF receiver that you would like to pair with).



Step 2: Click the "Learning Key" button on RF receiver or re-power on the receiver three times continuously to set it into pairing status

Step 3: Choose one zone and click I or O of the zone (e.g. zone 2), LED lights connected with the RF receiver flicker once means the receiver is paired with zone 2 successfully.

Note: one receiver can be paired with max 8 remote controls.

Installation

1. Remove battery insulator

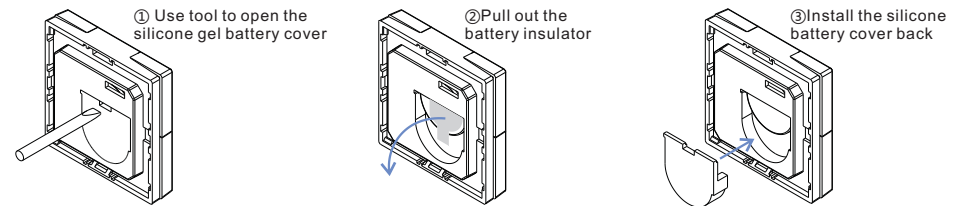

2. Install the controller to wall (2 methods)

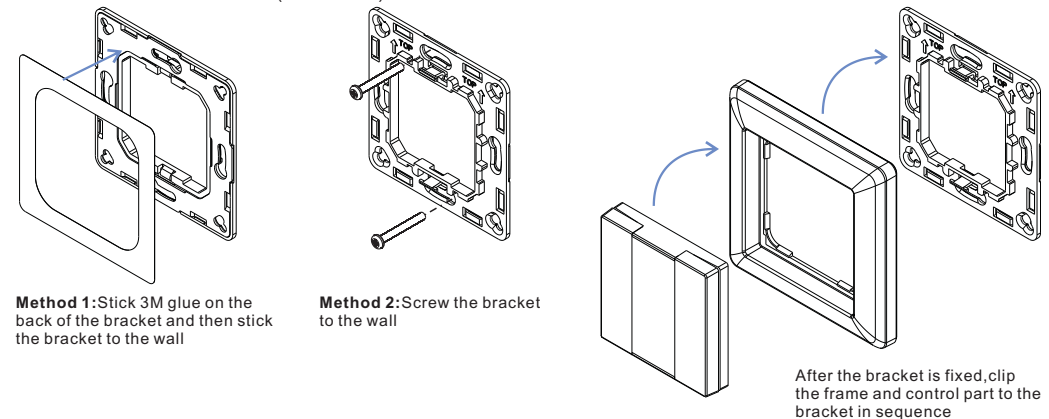

The key part of this controller is a universal, standard size design switch element that can be integrated in numerous frames by different manufactures as below list:

BEKER	S1, B1, B3, B7 glass
GIRA	Standard55, E2, Event, Esprit
JUNG	A500, Aplus
MERTEN	M-smart, M-Arc, M-Plan